

EmbeddedDNA[®]

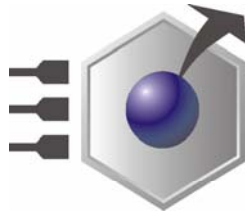

EuroTech
THE COMPLETE EMBEDDED PC SOLUTION

An0031

CPU-1232; TFT Digital Interface

Rev. 1.0

Sep. 2003

COPYRIGHT 1994-2003 Eurotech S.p.A. All Rights Reserved.

ABOUT THIS MANUAL

This application note contains information about the TFT Digital Interface installed on the CPU-1232.



Via J. Linussio 1
33020 AMARO (UD)
ITALY

Phone: +39 0433 485 411
Fax: +39 0433 485 499

web: <http://www.eurotech.it>
e-mail: <mailto:sales@eurotech.it>



NOTICE

Although all the information contained herein has been carefully verified, Eurotech S.p.A. assumes no responsibility for errors that might appear in this document, or for damage to property or persons resulting from an improper use of this manual and of the related software. Eurotech S.p.A. reserves the right to change the contents and form of this document, as well as the features and specifications of its products at any time, without notice.

Trademarks and registered trademarks appearing in this document are the property of their respective owners

Conventions

The following table lists conventions used throughout this guide.

Icon	Notice Type	Description
	Information note	Important features or instructions
	Warning	Information to alert you to potential damage to a program, system or device or potential personal injury

(This page is intentionally left blank.)

Table of Contents

Conventions	3
Table of Contents	5
Chapter 1 CPU-1232 TFT Digital Interface	7
TFT Digital Interface Overview	7
J19 TFT Digital Interface Connector	8
J19 TFT Digital Interface Pin Out.....	9
J19 TFT Digital Interface Signal Description.....	10
Chapter 2 BIOS Setup	11
CPU-1232 BIOS Menu.....	11
CPU-1232 BIOS Flat Panel parameters	12
Defining CPU-1232 BIOS Parameters.....	12
Timings Diagrams	14
Chapter 3 Connecting the TFT-LCD to the CPU-1232.....	16

(This page is intentionally left blank.)

Chapter 1 CPU-1232 TFT Digital Interface

This brief application note contains information about using the CPU-1232 TFT digital interface to help users connect TFT-LCD panels to the CPU-1232 module.

TFT Digital Interface Overview

The CPU-1232 allows users to connect various models of LCD-TFT flat panel displays via its J19 connector. The following table shows the supported LCD-TFT video resolutions

Resolution	Simultaneous Colours	Refresh Rate (Hz)
640x480	8bpp 256 colours	60
640x480	16bpp 64K colours	60
800x600	8bpp 256 colours	60
800x600	16bpp 64K colours	60
1024x768	8bpp 256 colours	60
1024x768	16bpp 64K colours	60

Table 1. LCD-TFT video resolutions (*)

(*)- This list is not meant to be a complete list of all the possible supported TFT video

For further info about other/new LCD-TFT flat panels supported, please contact the Eurotech Customer Support Service.

J19 TFT Digital Interface Connector

The TFT digital interface is accessible via the J19 connector, which is a 20x2 pitch 1.25mm SMT connector.

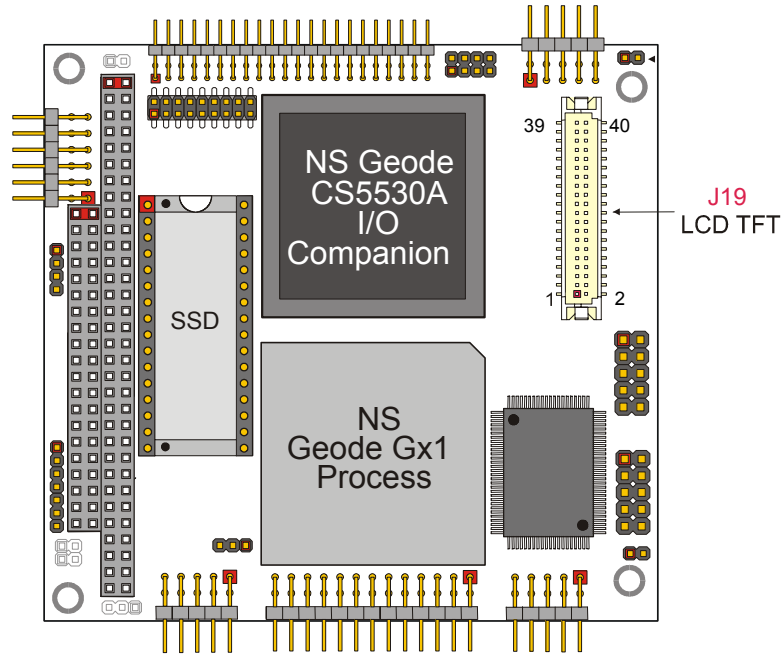

Figure 1. Connectors layout

The following table shows the J19 connector type and its matching models:

Connector Reference	Connector Type
J19 Used Connector	Hirose DF13-40DP-1.25V
J19 Corresponding connector	Hirose DF13-40DS-1.25C

Table 2. J19 mating connectors

For further information about connectors (electrical, mechanical, ...) please refer to the Hirose website: <http://www.hirose.com/> referring to the DF13 connector family.

J19 TFT Digital Interface Pin Out

The following table describes the J19 TFT Digital Interface connector signals:

Pin Number	Function	Pin Number	Function
2	Reserved	1	GND
4	GND	3	GND
6	NC	5	VDD
8	GND	7	VDD
10	GREEN5 (MSB)	9	FP_HSYNC
12	GREEN4	11	GND
14	GREEN3	13	FP_VSYNC
16	GREEN2	15	VDD
18	GND	17	VDD
20	GREEN1	19	Data Enable
22	GREEN0 (LSB)	21	GND
24	BLUE5 (MSB)	23	RED5 (MSB)
26	BLUE4	25	RED4
28	GND	27	RED3
30	BLUE3	29	VDD Enable
32	BLUE2	31	BackLight Enable
34	BLUE1	33	RED2
36	BLUE0 (LSB)	35	RED1
38	GND	37	RED0 (LSB)
40	Dot Clock	39	GND

Table 3. J19 TFT Digital Interface connector pinout

For physical correspondence with the J19 connector pins, please refer to Figure 1.

The purpose of the information shown herein is to help the user properly build the cable for connecting the digital interface of the CPU-1232 with a TFT LCD Panel.

Reducing the cable length will reduce interferences to the TFT LCD digital signals.

J19 TFT Digital Interface Signal Description

The digital TFT interface signals are described in the following table:

SIGNAL NAME	Description	Electrical Characteristics
Dot Clock	Pixel Port Clock Dot Clock is the pixel dot clock output. It clocks the pixel data.	TTL 8mA $V_{HMAX} = 3.3V$
FP_HSYNC	Flat Panel Horizontal Sync Flat Panel Horizontal Sync establishes the line rate and horizontal Retrace interval for a TFT display.	TTL 8mA $V_{HMAX} = 3.3V$
FP_VSYNC	Flat Panel Vertical Sync Flat Panel Vertical Sync establishes the screen refresh rate and vertical retrace interval for a TFT display.	TTL 8mA $V_{HMAX} = 3.3V$
ENA_DISP	Display Enable Display Enable indicates the active display portion of a scan line.	TTL 8mA $V_{HMAX} = 3.3V$
VDD ENABLE		TTL 8mA $V_{HMAX} = 3.3V$
DATA ENABLE	This is a data valid signal	TTL 8mA $V_{HMAX} = 3.3V$
BACKLIGHT ENABLE	This is a useful signal which allow you to control the switching on-off of the lamps	TTL 8mA $V_{HMAX} = 3.3V$
RED[5:0]	Graphics Red Pixel Data Bus This bus drives graphics pixel data synchronous to the Dot Clock output.	TTL 8mA $V_{HMAX} = 3.3V$
GREEN[5:0]	Graphics Green Pixel Data Bus This bus drives graphics pixel data synchronous to the Dot Clock output.	TTL 8mA $V_{HMAX} = 3.3V$
BLUE[5:0]	Graphics Blue Pixel Data Bus This bus drives graphics pixel data synchronous to the Dot Clock output.	TTL 8mA $V_{HMAX} = 3.3V$
VDD	Power Supply	+5V +/- 5%
GND	Ground	Ground

Table 4. Signal Description - Electrical Characteristics

Chapter 2 BIOS Setup

To enable the TFT Digital Interface functionality, the user should properly configure the BIOS settings. This section will show which BIOS settings to modify to properly control the LCD-TFT. For further information on how to set the BIOS, please refer to the CPU-1232 user manual.

CPU-1232 BIOS Menu

After entering BIOS setup (pressing the “F2” key during the boot time), select the Flat Panel page using the cursor arrows. The following image will appear on the screen.

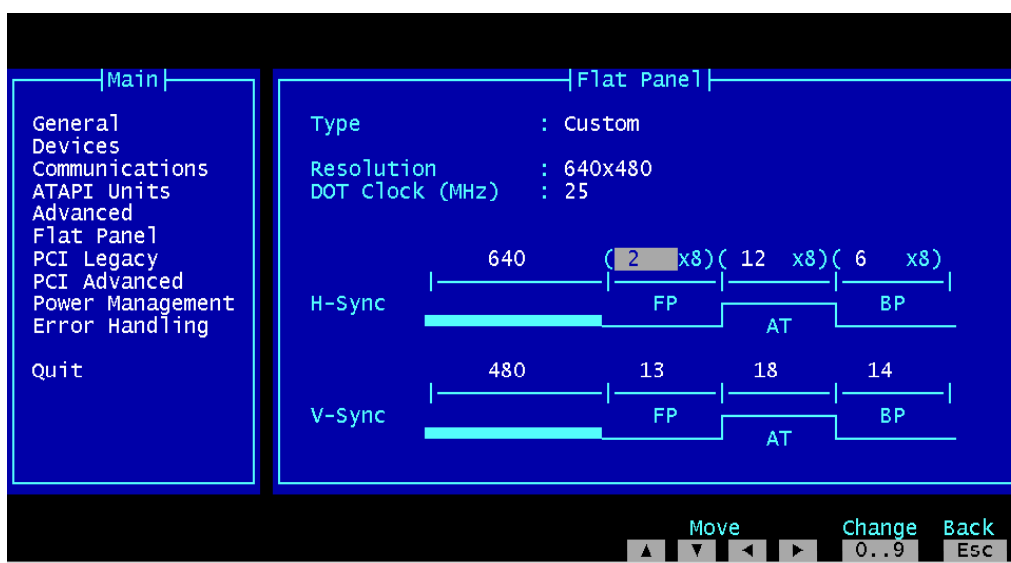

Figure 2. BIOS setup - Flat Panel section

CPU-1232 BIOS Flat Panel parameters

This is a brief description of the fields that can be modified in the BIOS Setup their default value:

Field	Description		Default Value
Type	Disabled	Disabled	Disabled
	Custom	Custom parameters	
	Hitachi 800x600 (38MHz)		
	LG 800x600 (38MHz)		
	NEC 800x600 (38MHz)		
	Sharp 800x600 (40MHz)		
Resolution	640x480	Select the proper graphical resolution	640x480
	800x600		
	1024x768		
Dot Clock (MHz)	Dot Clock Frequency in MHz		0
HSync FP	Front Porch - Horizontal Sync : This Value must be recognized from the TFT Display Data-Sheet.		0
HSync AT	Active Time - Horizontal Sync		0
HSync BP	Back Porch - Horizontal Sync		0
VSyn FP	Front Porch - Vertical Sync		0
VSyn AT	Active Time - Vertical Sync		0
VSyn BP	Back Porch - Vertical Sync		0

Table 5. BIOS Flat Panel Options

To insert the correct parameters, the user should refer to the information contained into the TFT-LCD datasheet to which you want to connect.

Sometimes, when running CRT and TFT video at the same time, the image shown on the CRT could appear rescaled and shifted. This happens because the parameters inserted for the TFT interface also modifies the CRT visualization.

Defining CPU-1232 BIOS Parameters

As previously mentioned, to enter the proper parameters into the Flat Panel BIOS settings, the user should refer to the TFT-LCD datasheet.

In Table 6 is shown an example of a timing table referring to a 640x480 TFT-LCD.

Parameter		Symbol	Min.	Typ.	Max.	Unit	Remarks
CLK	Frequency	1/fo	21.0	25.175	29.0	MHz	39.722 ns (Typ.)
	Duty	tch/fo	0.4	0.5	0.6	–	–
	Rise, fall	torf	–	–	10	ns	–
Hsync	Period	th	30.0	31.778	33.6	μ s	31.469 kHz (Typ.)
			–	800	–	CLK	
	Display period	thd	640			CLK	–
	Front-porch	thf	16			CLK	Fixed timing mode
			2	16	–	CLK	DE mode
	Pulse width	thp*	10	96	–	CLK	Fixed timing mode
			10	96	–	CLK	DE mode
	Back-porch	thb*	4	48	–	CLK	Fixed timing mode
			4	48	–	CLK	DE mode
	thp + thb*		144			CLK	Fixed timing mode
			14	144	–	CLK	DE mode
	CLK-Hsync timing	thch	12	–	–	ns	–
	Hsync-CLK timing	thcs	8	–	–	ns	–
	Hsync-Vsync timing	tvh	1	–	–	CLK	1CLK = 39.722 ns (Typ.)
Vsync-Hsync timing	tvh	30	–	–	ns	–	
Rise, fall	thrf	–	–	10	ns	–	
Vsync	Period	tv	16.1	16.883	17.2	ms	59.94 Hz (Typ.)
			–	525	–	H	
	Display period	tvd	480			H	–
	Front-porch	tvf	12			H	Fixed timing mode
			1	12	–	H	DE mode
	Pulse width	tvp*	1	2	–	H	Fixed timing mode
			1	2	–	H	DE mode
	Back-porch	tvb*	4	31	–	H	Fixed timing mode
			4	31	–	H	DE mode
	tvp + tvb*		33			H	Fixed timing mode
5			33	–	H	DE mode	
Rise, fall		–	–	10	ns	–	
DATA R0 - R5 G0 - G5 B0 - B5	CLK-DATA timing	tds	8	–	–	ns	–
	DATA-CLK timing	tdh	12	–	–	ns	–
	Rise, fall	tdrf	–	–	10	ns	–
DE	DE-CLK timing	tes	8	–	–	ns	DE mode
	CLK-DE timing	teh	12	–	–	ns	
	Rise, fall	terf	–	–	10	ns	

Table 6. Timing Characteristic Example for a TFT-LCD

The following instructions are an example on how to define the values to enter in the Setup, relating to timing characteristics shown in Table 6.

BIOS Field	BIOS Value	Notes
Type	Custom	We would enter custom parameters
Resolution	640x480	Obtained from the TFT-LCD datasheet, this is a characteristic.
Dot Clock (MHz)	25	Referring Table 6 CLK (1/Tc) Typical value. The reported value 25.175MHz is approximated to 25Mhz
HSync FP	2	Referring Table 6 HSync Front Porch (thf) Typical value. The reported value 16CLK. So the value you've to enter the BIOS is 2 to obtain $16 = (2 \times 8)$
HSync AT	12	Referring Table 6 HSync Pulse width (thp*) Typical value. The reported value 96CLK. The value you've to enter the BIOS is 12 to obtain $96 = (12 \times 8)$
HSync BP	6	Referring Table 6 HSync Pulse Back-porch (thb*) Typical value. The reported value 48CLK. The value you've to enter the BIOS is 6 to obtain $48 = (6 \times 8)$
VSsync FP	12	Referring Table 6 VSsync Front Porch (tvf) Typical value. The reported value 12CLK.
VSsync AT	2	Referring Table 6 VSsync Pulse width (tvp*) Typical value. The reported value 2 H.
VSsync BP	31	Referring Table 6 VSsync Back Porch (thb*) Typical value. The reported value 31CLK.

Table 7. Flat Panel BIOS parameters

Timings Diagrams

The followings images show a graphical mode to represent timing data. The information is not represented in the same graphical order shown into the Flat Panel BIOS setup, but the contents are the same.

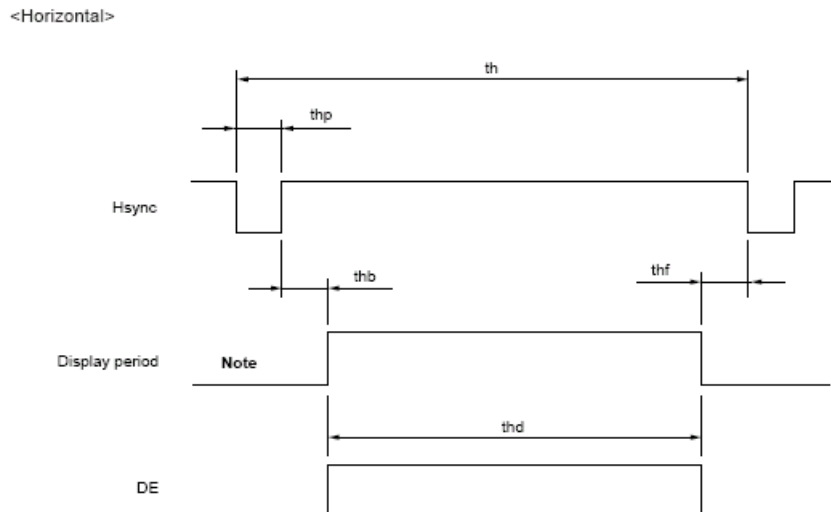

Figure 3. Timing Diagram Horizontal Mode

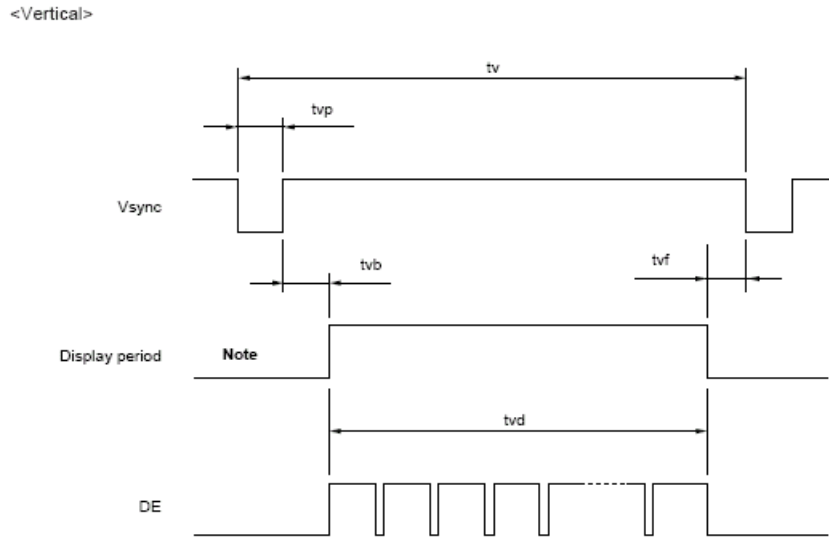

Figure 4. Timing Diagram Vertical Mode

The previous Figures may be useful to verify graphically if the entered BIOS parameters match the TFT timing diagram.

Regarding the timing, the following relationships should be ensured:

Horizontal Sync. :

Period (t_h) = Display Period (t_{hd}) + Front Porch (t_{hf}) + Pulse Width (t_{hp}^*) + Back Porch (t_{hb}^*)

Vertical Sync. :

Period (t_v) = Display Period (t_{vd}) + Front Porch (t_{vf}) + Pulse Width (t_{vp}^*) + Back Porch (t_{vb}^*)

Practically, referring to Table 6 and to Table 7, the results are:

Horizontal Sync : $800 = 640 + 16 + 96 + 48$

Vertical Sync : $525 = 480 + 12 + 31 + 2$

Chapter 3 Connecting the TFT-LCD to the CPU-1232

This section contains a brief checklist of the actions to perform before connecting a TFT–LCD display to the CPU-1232.

- ❑ First of all, download all information about the TFT-LCD module and its inverter selected;
- ❑ Verify that the resolution of the TFT panel is compatible with and supported by the resolution shown in Table 1 of this application note;
- ❑ Read carefully the TFT-LCD datasheet, in particular the Electrical Characteristics that must be compatible with the electrical interface of the CPU-1232 TFT LCD interface referred to in Table 4;
- ❑ Consulting the TFT-LCD datasheet and the Table 3 CPU-1232 connector pin-out, write a table with the connections between the J19 CPU-1232 connector and the TFT-LCD selected; this may be useful when building the connection cable;
- ❑ Consulting the TFT-LCD inverter datasheet and Table 3 CPU-1232 connector pin-out, make the proper cable.
- ❑ Refer to the TFT-LCD input signal timing datasheet section to detect the parameters to insert into the CPU-1232 BIOS Flat Panel section and calculate it as described in the Chapter 2 BIOS Setup.
- ❑ To connect the system, first carefully verify the connections cable, the BIOS settings and all the information to prevent erroneous damages to the system.
- ❑ After verifying the information, power up the system verifying all information is properly displayed on the TFT-LCD module. Try some graphical test programs to detect the functionality of the images.